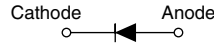

Ultrafast Soft Recovery Diode, 80 A FRED PT™

PowerTab™

FEATURES

- Ultrafast recovery
- 175 °C operating junction temperature
- Screw mounting only
- Lead (Pb)-free plating
- Designed and qualified for industrial level

**RoHS
COMPLIANT**
BENEFITS

- Reduced RFI and EMI
- Higher frequency operation
- Reduced snubbing
- Reduced parts count

DESCRIPTION/APPLICATIONS

These diodes are optimized to reduce losses and EMI/RFI in high frequency power conditioning systems.

The softness of the recovery eliminates the need for a snubber in most applications. These devices are ideally suited for HF welding, power converters and other applications where switching losses are not significant portion of the total losses.

PRODUCT SUMMARY

t_{rr} (typical)	50 ns
$I_{F(AV)}$	80 A
V_R	400 V

ABSOLUTE MAXIMUM RATINGS

PARAMETER	SYMBOL	TEST CONDITIONS	MAX.	UNITS
Cathode to anode voltage	V_R		400	V
Continuous forward current	$I_{F(AV)}$	$T_C = 101\text{ °C}$	80	A
Single pulse forward current	I_{FSM}	$T_C = 25\text{ °C}$	800	
Maximum repetitive forward current	I_{FRM}	Square wave, 20 kHz	160	
Operating junction and storage temperatures	T_J, T_{Stg}		- 55 to 175	°C

ELECTRICAL SPECIFICATIONS ($T_J = 25\text{ °C}$ unless otherwise specified)

PARAMETER	SYMBOL	TEST CONDITIONS	MIN.	TYP.	MAX.	UNITS
Breakdown voltage, blocking voltage	V_{BR}, V_r	$I_R = 100\text{ }\mu\text{A}$	400	-	-	V
Forward voltage	V_F	$I_F = 80\text{ A}$	-	1.1	1.3	
		$I_F = 80\text{ A}, T_J = 175\text{ °C}$	-	0.92	1.08	
		$I_F = 80\text{ A}, T_J = 125\text{ °C}$	-	0.98	1.15	
Reverse leakage current	I_R	$V_R = V_R$ rated	-	-	50	μA
		$T_J = 150\text{ °C}, V_R = V_R$ rated	-	-	2	mA
Junction capacitance	C_T	$V_R = 200\text{ V}$	-	50	-	pF
Series inductance	L_S	Measured lead to lead 5 mm from package body	-	3.5	-	nH

DYNAMIC RECOVERY CHARACTERISTICS ($T_J = 25\text{ }^\circ\text{C}$ unless otherwise specified)						
PARAMETER	SYMBOL	TEST CONDITIONS	MIN.	TYP.	MAX.	UNITS
Reverse recovery time	t_{rr}	$I_F = 1\text{ A}$, $di_F/dt = 200\text{ A}/\mu\text{s}$, $V_R = 30\text{ V}$	-	50	60	ns
		$T_J = 25\text{ }^\circ\text{C}$	-	87	-	
		$T_J = 125\text{ }^\circ\text{C}$	-	151	-	
Peak recovery current	I_{RRM}	$T_J = 25\text{ }^\circ\text{C}$	-	9.3	-	A
		$T_J = 125\text{ }^\circ\text{C}$	-	17.2	-	
Reverse recovery charge	Q_{rr}	$T_J = 25\text{ }^\circ\text{C}$	-	405	-	nC
		$T_J = 125\text{ }^\circ\text{C}$	-	1300	-	

THERMAL - MECHANICAL SPECIFICATIONS						
PARAMETER	SYMBOL	TEST CONDITIONS	MIN.	TYP.	MAX.	UNITS
Thermal resistance, junction to case	R_{thJC}		-	-	0.70	K/W
Thermal resistance, junction to heatsink	R_{thCS}	Mounting surface, flat, smooth and greased	-	0.2	-	
Weight			-	-	5.02	g
			-	0.18	-	oz.
Mounting torque			1.2 (10)	-	2.4 (20)	N · m (lbf · in)
Marking device		Case style PowerTab™	80EBU04			

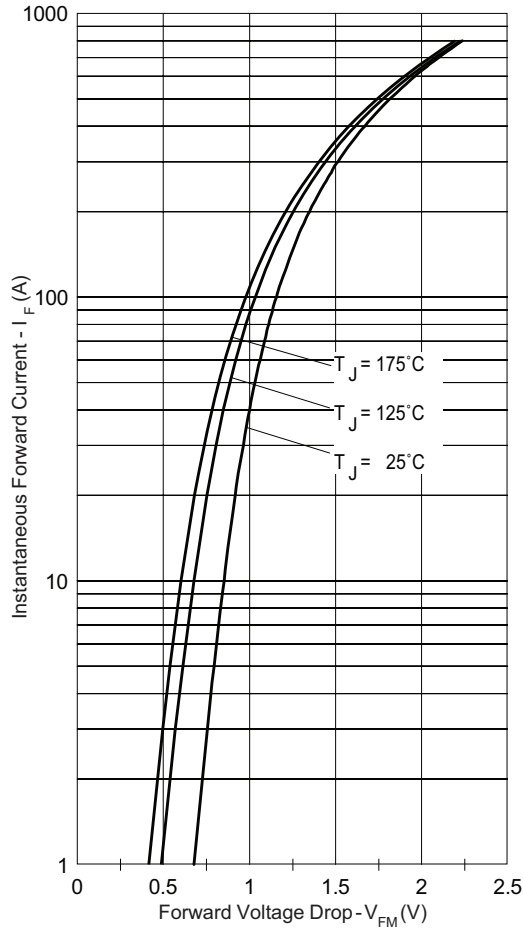

Fig. 1 - Maximum Forward Voltage Drop Characteristics

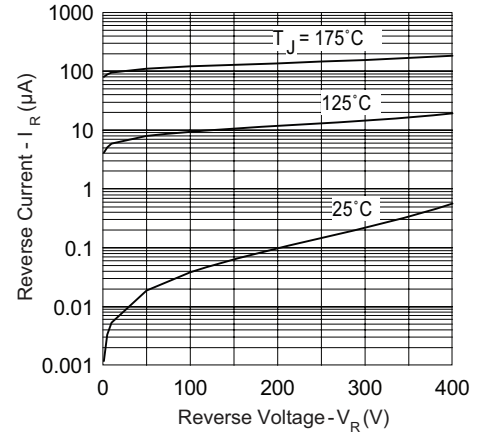

Fig. 2 - Typical Values of Reverse Current vs. Reverse Voltage

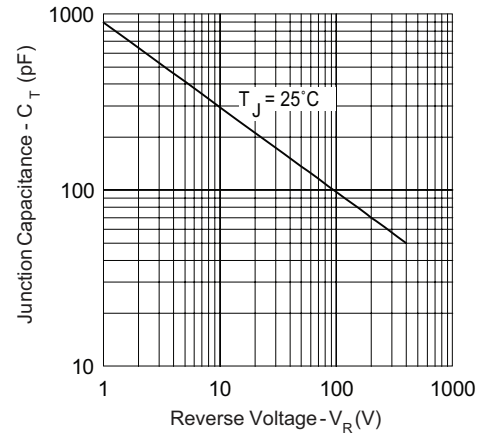
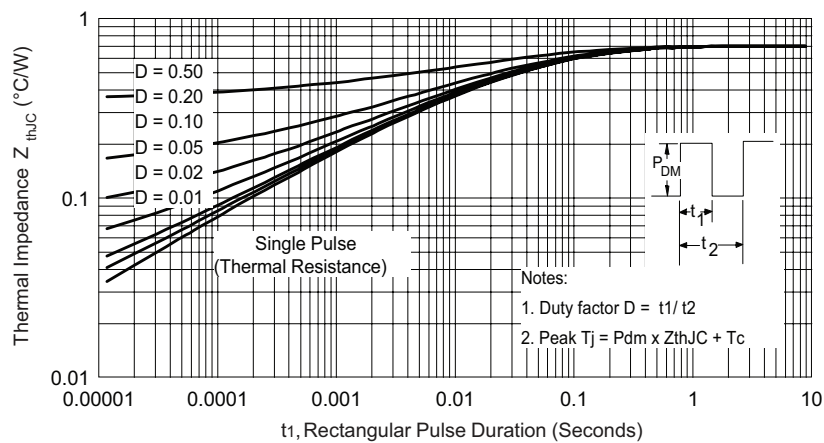

Fig. 3 - Typical Junction Capacitance vs. Reverse Voltage

 Fig. 4 - Maximum Thermal Impedance Z_{thJC} Characteristics

Vishay High Power Products Ultrafast Soft Recovery Diode,
80 A FRED PT™

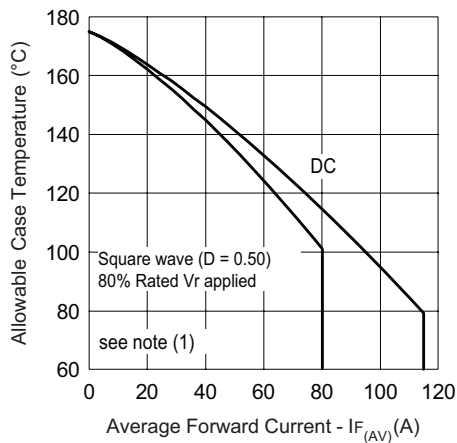

Fig. 5 - Maximum Allowable Case Temperature vs. Average Forward Current

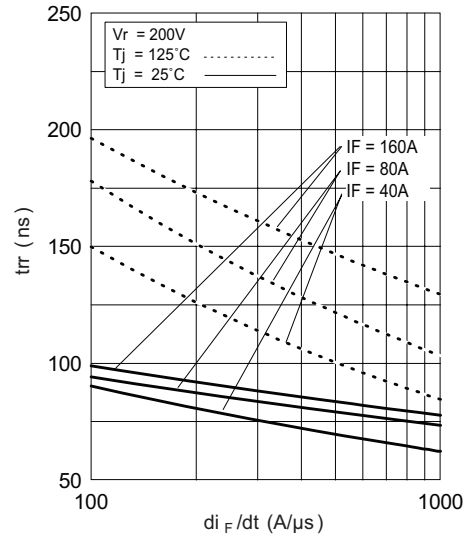

Fig. 7 - Typical Reverse Recovery Time vs. di_F/dt

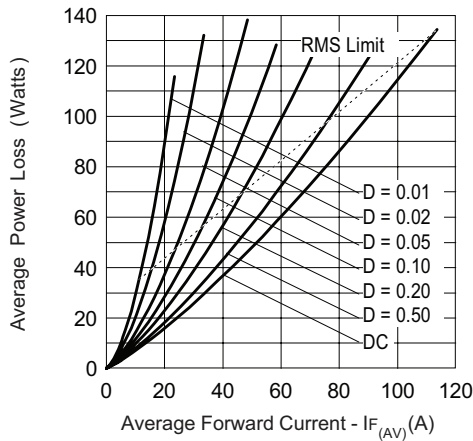

Fig. 6 - Forward Power Loss Characteristics

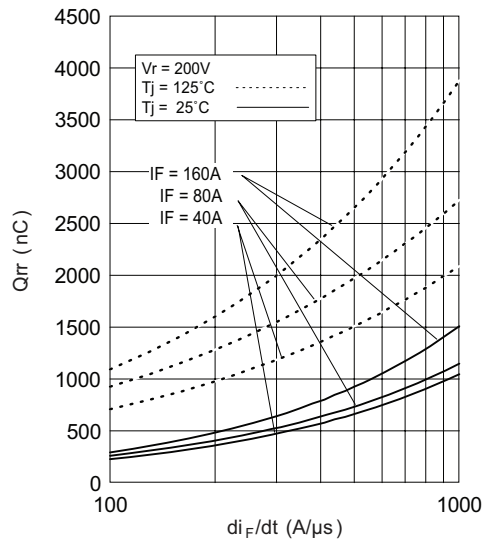

Fig. 8 - Typical Stored Charge vs. di_F/dt

Note

- (1) Formula used: $T_C = T_J - (P_d + P_{d_{REV}}) \times R_{thJC}$;
 P_d = Forward power loss = $I_{F(AV)} \times V_{FM}$ at $(I_{F(AV)}/D)$ (see fig. 6);
 $P_{d_{REV}}$ = Inverse power loss = $V_{R1} \times I_R (1 - D)$; I_R at $V_{R1} = 80\%$ rated V_R

Ultrafast Soft Recovery Diode, Vishay High Power Products 80 A FRED PT™

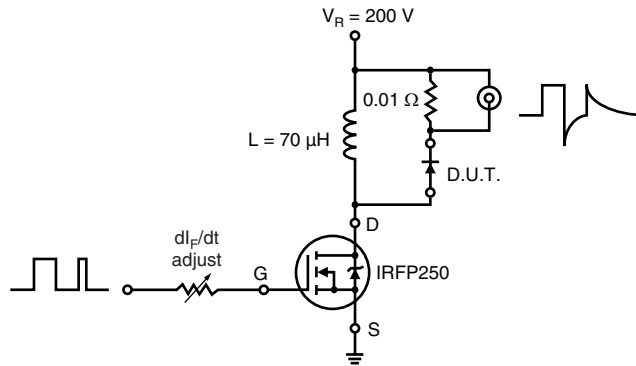
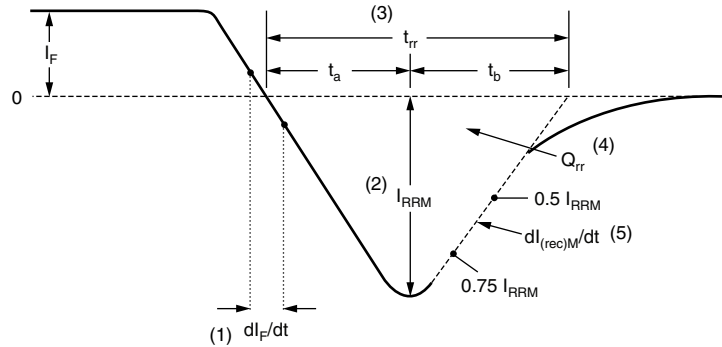

Fig. 9 - Reverse Recovery Parameter Test Circuit



(1) di_f/dt - rate of change of current through zero crossing

(2) I_{RRM} - peak reverse recovery current

(3) t_{rr} - reverse recovery time measured from zero crossing point of negative going I_F to point where a line passing through $0.75 I_{RRM}$ and $0.50 I_{RRM}$ extrapolated to zero current.

(4) Q_{rr} - area under curve defined by t_{rr} and I_{RRM}

$$Q_{rr} = \frac{t_{rr} \times I_{RRM}}{2}$$

(5) $di_{(rec)M}/dt$ - peak rate of change of current during t_b portion of t_{rr}

Fig. 10 - Reverse Recovery Waveform and Definitions

80EBU04



Vishay High Power Products Ultrafast Soft Recovery Diode,
80 A FRED PT™

ORDERING INFORMATION TABLE

Device code	80	E	B	U	04
	①	②	③	④	⑤

- 1** - Current rating (80 = 80 A)
- 2** - Single diode
- 3** - PowerTab™ (ultrafast/hyperfast only)
- 4** - Ultrafast recovery
- 5** - Voltage rating (04 = 400 V)

LINKS TO RELATED DOCUMENTS	
Dimensions	http://www.vishay.com/doc?95240
Part marking information	http://www.vishay.com/doc?95370



Disclaimer

All product specifications and data are subject to change without notice.

Vishay Intertechnology, Inc., its affiliates, agents, and employees, and all persons acting on its or their behalf (collectively, "Vishay"), disclaim any and all liability for any errors, inaccuracies or incompleteness contained herein or in any other disclosure relating to any product.

Vishay disclaims any and all liability arising out of the use or application of any product described herein or of any information provided herein to the maximum extent permitted by law. The product specifications do not expand or otherwise modify Vishay's terms and conditions of purchase, including but not limited to the warranty expressed therein, which apply to these products.

No license, express or implied, by estoppel or otherwise, to any intellectual property rights is granted by this document or by any conduct of Vishay.

The products shown herein are not designed for use in medical, life-saving, or life-sustaining applications unless otherwise expressly indicated. Customers using or selling Vishay products not expressly indicated for use in such applications do so entirely at their own risk and agree to fully indemnify Vishay for any damages arising or resulting from such use or sale. Please contact authorized Vishay personnel to obtain written terms and conditions regarding products designed for such applications.

Product names and markings noted herein may be trademarks of their respective owners.